

# Inverter RS Smart

Rev. 04 - 10/2022

This manual is also available in [HTML5](#).

# Table of Contents

<b>1. Safety Instructions</b> .....	<b>1</b>
<b>2. General Description</b> .....	<b>3</b>
2.1. Frequency shift function .....	3
2.2. High power inverter .....	3
2.3. Interfacing and Communications .....	3
2.4. Battery charger .....	3
2.5. Setup options .....	4
<b>3. Installation</b> .....	<b>5</b>
3.1. Location of the inverter .....	5
3.2. Battery and battery lead requirements .....	5
3.3. Cable connection sequence .....	6
3.4. Connection to the load .....	6
3.5. VE.Direct .....	6
3.6. VE.Can .....	6
3.7. Bluetooth .....	7
3.8. User I/O .....	7
3.8.1. Remote on/off connector .....	7
3.8.2. Programmable relay .....	7
3.8.3. Voltage sense .....	7
3.8.4. Temperature sensor .....	7
3.8.5. Programmable analog/digital input ports .....	7
3.8.6. User I/O terminal diagram .....	8
3.8.7. User I/O functions .....	8
<b>4. Configuration</b> .....	<b>9</b>
4.1. Configuring via the VictronConnect app .....	9
4.2. Battery settings .....	10
4.3. Inverter settings .....	12
4.4. Programmable relay .....	13
4.5. Connecting to AC PV inverters .....	13
<b>5. Operation</b> .....	<b>14</b>
5.1. Device display .....	14
5.2. Protections and automatic restarts .....	14
5.2.1. Overload .....	14
5.2.2. Low battery voltage thresholds (adjustable in VictronConnect) .....	15
5.2.3. High battery voltage .....	15
5.2.4. High temperature .....	15
<b>6. Troubleshooting and Support</b> .....	<b>16</b>
6.1. Error Codes .....	16
6.1.1. Error 2 - Battery voltage too high .....	16
6.1.2. Error 3, Err 4 - Remote temperature sensor failure .....	16
6.1.3. Error 5 - Remote temperature sensor failure (connection lost) .....	16
6.1.4. Error 6, Error 7 - Remote battery voltage sense failure .....	16
6.1.5. Error 8 - Remote battery voltage sense failure (connection lost) .....	16
6.1.6. Error 11 - Battery high ripple voltage .....	16
6.1.7. Error 14 - Battery low temperature .....	16
6.1.8. Error 20 - Maximum Bulk-time exceeded .....	16
6.1.9. Error 22, 23 - Internal temperature sensor failure .....	17
6.1.10. Error 26 - Terminal overheated .....	17
6.1.11. Error 27 - Charger short circuit .....	17
6.1.12. Error 28 - Power stage issue .....	17
6.1.13. Error 29 - Over-Charge protection .....	17
6.1.14. Error 43 - Inverter shutdown (Ground Fault) .....	17
6.1.15. Error 50, Error 52 - Inverter overload, Inverter peak current .....	17
6.1.16. Error 51 - Inverter temperature too high .....	17
6.1.17. Error 53, Error 54 - Inverter output voltage .....	18
6.1.18. Error 55, Error 56, Error 58 - Inverter self test failed .....	18
6.1.19. Error 57 - Inverter ac voltage on output .....	18

6.1.20. Notification 65 - Communication warning .....	18
6.1.21. Notification 66 - Incompatible device .....	18
6.1.22. Error 67 - BMS Connection lost .....	18
6.1.23. Error 68 - Network misconfigured .....	18
6.1.24. Error 114 - CPU temperature too high .....	18
6.1.25. Error 116 - Calibration data lost .....	18
6.1.26. Error 119 - Settings data lost .....	19
6.1.27. Error 121 - Tester fail .....	19
6.1.28. Err 200, X95 - Internal DC voltage error .....	19
6.1.29. Err 201 - Internal DC voltage error .....	19
6.1.30. Err 203, Err 205, Err 212, Err 215 - Internal supply voltage error .....	19
<b>7. Warranty .....</b>	<b>20</b>
<b>8. Technical Specifications .....</b>	<b>21</b>
<b>9. Appendix .....</b>	<b>23</b>
9.1. Appendix A : Connection Overview .....	23
9.2. Appendix B : Block Diagram .....	24
9.3. Appendix C : Example Wiring Diagram .....	25
9.4. Appendix D : Dimensions .....	26

# 1. Safety Instructions



## ELECTRIC SHOCK HAZARD

Please read this manual carefully before the product is installed and put into use.

This product is designed and tested in accordance with international standards. The equipment should be used for the designated application only.

Refer to the specifications provided by the manufacturer of the battery to ensure that the battery is suitable for use with this product. The battery manufacturer's safety instructions should always be observed.

Protect the solar modules from incident light during installation, e.g. cover them.

Never touch uninsulated cable ends.

Use only insulated tools.

Connections must always be made in the sequence described in the installation section of this manual.

The installer of the product must provide a means for cable strain relief to prevent the transmission of stress to the connections.

In addition to this manual, the system operation or service manual must include a battery maintenance manual applicable to the type of batteries used. The battery must be placed in a well-ventilated area.



## SELECTION OF WIRE CONDUCTORS

Use flexible multistranded copper cable for the battery and PV connections.

The maximum diameter of the individual strands is 0,4mm/0,125mm<sup>2</sup> (0.016 inch/AWG26).

A 25mm<sup>2</sup> cable, for example, should have at least 196 strands (class 5 or higher stranding according to VDE 0295, IEC 60228 and BS6360).

An AWG2 gauge cable should have at least 259/26 stranding (259 strands of AWG26)

Maximum operating temperature:  $\geq 90^{\circ}\text{C}$

Example of suitable cable: class 5 "Tri-rated" cable (it has three approvals: American (UL), Canadian (CSA) and British (BS)).

In case of thicker strands the contact area will be too small and the resulting high contact resistance will cause severe overheating, eventually resulting in fire.



## RISK OF INJURY OR DEATH

The internals can carry a 400-500V DC voltage even when the product is off!

Input and/or output terminals may still be dangerously energized, even when the equipment is switched off. Always disconnect all power connections (e.g. the battery, DC solar isolator, etc) and wait at least 5 minutes before carrying out work on the product.

The product has no internal user-serviceable components. Do not remove the front plate or operate the product if any panels have been removed. All servicing must be undertaken by qualified personnel.

Please read the installation instructions in the installation manual before installing the equipment.

This is a Safety Class I product (supplied with a protective grounding terminal). The chassis must be grounded. Whenever it is likely that the grounding protection has been damaged, the product must be turned off and secured against unintended operation; please contact qualified service staff.

### Environment and Access

Ensure that the equipment is used under the correct ambient conditions. Never operate the product in a wet or dusty environment. Never use the product where there is a risk of gas or dust explosions. Ensure there is adequate free space for ventilation above and below the product and check that the ventilation vents are not blocked.

Installation of this product must in a location that restricts access by persons (including children) with reduced physical, sensory or mental capabilities, or lack of experience and knowledge, unless they have been given supervision or instruction concerning use of the appliance by a person responsible for their safety.

The connections to live parts should be covered after installation.

## 2. General Description

The Inverter RS Smart is a Inverter.

It is designed to operate with a 48V battery bank and produces a pure AC sine wave at 230V.

### 2.1. Frequency shift function

When external PV inverters are connected to the output of the inverter, excess solar energy is used to recharge the batteries. Once the battery absorption voltage is reached, charge current will reduce by shifting the output frequency higher. This frequency shift is automatic and does not require configuration on the Inverter RS, though the AC PV inverter may require additional configuration. This feature is used for battery over charge protection and solar assist. It does not allow charging the battery from an AC PV inverter to fully 100% State of Charge. To complete a full charge from solar, connect PV to the internal MPPT solar charger, or another DC MPPT.

### 2.2. High power inverter

**High peak power** - The inverter is able to supply a maximum AC output power to a peak 9000W or 50A AC, for 3 seconds. This supports smooth operation for motor start up and other demanding surge loads.

**Temperature Protected** - Over-temperature protection and power derating when temperature is high.

### 2.3. Interfacing and Communications

#### VE.Direct port and two VE.Can ports

The Inverter RS only supports a data connection to a GX device (i.e Cerbo GX) via the VE.Can port, and not the VE.Direct port. The VE.Direct port can be used to connect a GlobalLink 520 for remote data monitoring, or USB to VE.Direct dongle for VictronConnect access on a Windows computer.

#### Device Display

A 4 line LCD back-lit display shows operational information including battery levels, solar yield, and system icons.

#### User I/O connector:

- Aux 1, 2 input
- Programmable relay
- Battery voltage sense (Vsense)
- Battery temperature sense (Tsense)
- Remote H & Remote L - Configurable

#### Bluetooth Smart built-in

The wireless solution to set-up, monitor and update the controller using Apple and Android smartphones, tablets or other compatible devices.

#### Configuring and monitoring with VictronConnect

Configure with the VictronConnect app. Available for iOS, Android devices, as well as macOS and Windows computers. A VE.Direct to USB accessory is required for Windows systems; enter VictronConnect in the search box on our website and see the VictronConnect download page for details.

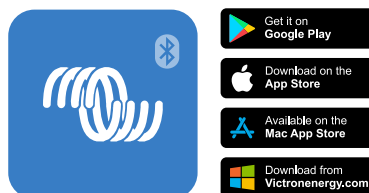

### 2.4. Battery charger

The batteries can be charged by solar if an AC PV grid inverter is connected the AC output. The maximum size of the grid converter can be 5000W. The maximum charge current is limited to 100A and will be reduced if battery voltage goes above 60V. A custom maximum charge current can be set in the VictronConnect app. Battery charging will take place up to approximately 98% battery state of charge.

The charger algorithm is the same as for the BlueSolar MPPT solar controllers. This provides built-in battery preset parameters, and allows for expert mode to define additional charging parameters.

## 2.5. Setup options

### Adaptive three step charging

The Charge Controller is configured for a three step charging process: Bulk – Absorption – Float.

A regular equalization charge can also be programmed.

Bulk- During this stage the controller delivers as much charge current as possible to rapidly recharge the batteries.

Absorption - When the battery voltage reaches the absorption voltage setting, the controller switches to constant voltage mode. When only shallow discharges occur the absorption time is kept short in order to prevent overcharging of the battery. After a deep discharge the absorption time is automatically increased to make sure that the battery is completely recharged.

Additionally, the absorption period is also ended when the charge current decreases to less than 2A.

Float - During this stage, float voltage is applied to the battery to maintain a fully charged state.

### Optional external voltage and temperature sensor

Wired connections are available for battery voltage and temperature sensing. The Solar Charger uses these measurements to optimize its charge parameters. The accuracy of the data it transmits will improve battery charging efficiency, and prolong battery life.

The Smart Battery Sense and other VE.Smart networking features are not currently supported.

### Remote on-off input

Remote L functions as 'allow to charge' in case lithium battery is selected and remote H functions as 'allow to discharge'. Use smallBMS for the RS with Victron lithium batteries.





### Programmable relay

Can be programmed (with a smartphone) to open or close on an alarm, or other events.

## 3. Installation

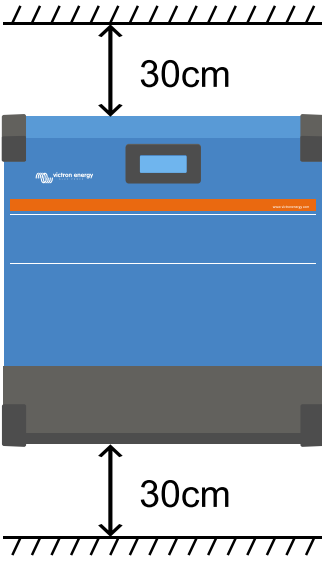
### 3.1. Location of the inverter

Table 1.

 <p>The diagram shows a blue and grey inverter unit mounted vertically. Above the unit, a double-headed arrow indicates a 30cm clearance to a ceiling. Below the unit, another double-headed arrow indicates a 30cm clearance to a floor. The unit has a 'victron energy' logo on the top left.</p>	<p>To ensure a trouble free operation of the inverter, it must be used in locations that meet the following requirements:</p> <ol style="list-style-type: none"> <li>Avoid any contact with water. Do not expose the inverter to rain or moisture.</li> <li>Do not place the unit in direct sunlight. Ambient air temperature should be between <math>-20^{\circ}\text{C}</math> and <math>40^{\circ}\text{C}</math> (humidity <math>&lt; 95\%</math> non-condensing).</li> <li>Do not obstruct the airflow around the inverter. Leave at least 30 centimeters clearance above and below the inverter, and preferably installed upright and vertical</li> </ol> <p>When the unit is running too hot, it will shut down. When it has reached a safe temperature level the unit will automatically restart again.</p>
	<p>This product contains potentially dangerous voltages. It should only be installed under the supervision of a suitable qualified installer with the appropriate training, and subject to local requirements. Please contact Victron Energy for further information or necessary training.</p>
	<p>Excessively high ambient temperature will result in the following:</p> <ul style="list-style-type: none"> <li>Reduced service life.</li> <li>Reduced charging current.</li> <li>Reduced peak capacity, or shutdown of the inverter.</li> </ul> <p>Never position the appliance directly above lead-acid batteries. The unit is suitable for wall mounting. For mounting purposes, a hook and two holes are provided at the back of the casing. The device must be fitted vertically for optimal cooling.</p>
	<p>For safety purposes, this product should be installed in a heat-resistant environment. You should prevent the presence of e.g. chemicals, synthetic components, curtains or other textiles, etc., in the immediate vicinity.</p>

**Try and keep the distance between the product and the battery to a minimum in order to minimise cable voltage losses**

### 3.2. Battery and battery lead requirements

In order to utilize the full capacity of the product, batteries with sufficient capacity and battery cables with sufficient cross section should be used. The use of undersized batteries or battery cables will lead to:

- Reduction in system efficiency.
- Unwanted system alarms or shutdowns.
- Permanent damage to system.

See table for MINIMUM battery and cable requirements.



Model		
Battery capacity Lead-acid		200 Ah
Battery capacity Lithium		50 Ah
Recommended DC fuse		125 A - 150 A
Minimum cross section (mm <sup>2</sup> ) per + and - connection terminal	0 - 2 m	35 mm <sup>2</sup>
	2 - 5 m	70 mm <sup>2</sup>

 Consult battery manufacture recommendations to ensure the batteries can take the total charge current of the system. Decision on battery sizing should be made in consultation with your system designer.

 Use a torque wrench with insulated box spanner in order to avoid shorting the battery.  
**Maximum torque: 14 Nm**  
 Avoid shorting the battery cables.

- Undo the two screws at the bottom of the enclosure and remove the service panel.
- Connect the battery cables.
- Tighten the nuts well for minimal contact resistance.

### 3.3. Cable connection sequence

Connect the cables in the following order:

1. Confirm correct battery polarity and then connect the battery.
2. If required, connect the remote on-off, and programmable relay, and communications cables

### 3.4. Connection to the load

Never connect the output of the inverter to another AC supply, such as a household AC wall outlet or AC wave forming petrol generator. Wave synchronising PV solar inverters can be connected to the AC output, see section on Frequency Shift Function for more information.

 The Inverter RS is a safety class I product (supplied with a ground terminal for safety purposes). **Its AC output terminals and/or grounding point on the outside of the product must be provided with an uninterruptible grounding point for safety purposes.**

The Inverter RS is provided with a ground relay that **automatically connects the Neutral output to the chassis**. This ensures the correct operation of the internal earth leakage switch and an earth leakage circuit breaker that is connected to the output.

- In a fixed installation, an uninterruptible grounding can be secured by means of the grounding wire of the AC input. Otherwise the casing must be grounded.
- In a mobile installation (for example, with a shore current plug), interrupting the shore connection will simultaneously disconnect the grounding connection. In that case, the casing must be connected to the chassis (of the vehicle) or to the hull or grounding plate (of the boat).

**Torque: 2 Nm**

### 3.5. VE.Direct

This can be used to connect a PC/laptop to configure the inverter with a VE.Direct to USB accessory. Can also be used to connect a Victron GlobalLink 520 to allow for remote data monitoring.

Note the VE.Direct port on the Inverter RS cannot be used to connect to a GX device, and the VE.Can connection must be used instead.

### 3.6. VE.Can

Used to connect to a GX Device, and/or daily-chain communications to other VE.Can compatible products such as the VE.Can MPPT range.

## 3.7. Bluetooth

Used to connect to the device via VictronConnect for configuration.

## 3.8. User I/O

### 3.8.1. Remote on/off connector

The remote on/off connector has two terminals, the "Remote L" and the "Remote H" terminal.

The Inverter RS ships with the remote on/off connector terminals connected to each other via a wire link.

Note that for the remote connector to be operational, the main on/off switch on the Inverter RS needs to be switched to "on"

The remote on/off connector has two different operational modes:

#### On/off mode (default):

The default function of the remote on/off connector is to remotely switch the unit on or off.

- The unit will switch on if "Remote L" and the "Remote H" are connected to each other (via a remote switch, relay or the wire link).
- The unit will switch off if "Remote L" and the "Remote H" are not connected to each other and are free floating.
- The unit will switch on if "Remote H" is connected to battery positive (Vcc).
- The unit will switch on if "Remote L" is connected to battery negative (GND).

#### 2-wire BMS mode:

This feature can be enabled via VictronConnect. Go to "battery settings" and then to "Remote mode". (see attached image)

Set the remote mode from "on/off" to "2-wire BMS".

In this mode, the "load", "load disconnect" or "allowed to discharge" signal and the "charger", "charger disconnect" or "allowed to charge" signals from a Victron lithium battery BMS are used to control the unit. They respectively turn the inverter off in case discharge is not allowed, and turn the solar charger off if charging is not allowed by the battery.

- Connect the BMS "load", "load disconnect" or "allowed to discharge" terminal to the Inverter RS Smart "Remote H" terminal.
- Connect the BMS "charger", "charge disconnect" or "allowed to charge" to the unit Inverter RS Smart "Remote L" terminal.

### 3.8.2. Programmable relay

Programmable relay which can be set for general alarm, DC under voltage or genset start/stop function. DC rating: 4A up to 35VDC and 1A up to 70VDC

### 3.8.3. Voltage sense

For compensating possible cable losses during charging, two sense wires can be connected directly to the battery or to the positive and negative distribution points. Use wire with a cross-section of 0,75mm<sup>2</sup>.

During battery charging, the charger will compensate the voltage drop over the DC cables up to a maximum of 1 Volt (i.e. 1V over the positive connection and 1V over the negative connection). If the voltage drop threatens to become larger than 1V, the charging current is limited in such a way that the voltage drop remains limited to 1V.

### 3.8.4. Temperature sensor

For temperature-compensated charging, the temperature sensor (supplied with the unit) can be connected. The sensor is isolated and must be fitted to the negative terminal of the battery. The temperature sensor can also be used for low temperature cut-off when charging lithium batteries (configured in VictronConnect).

### 3.8.5. Programmable analog/digital input ports

The product is equipped with 2 analog/digital input ports.

The digital inputs are 0-5v, and when a input is pulled to 0v it is registered as 'closed'

These ports can be configured in VictronConnect. For more information search Victron Community.

### 3.8.6. User I/O terminal diagram

Figure 1.

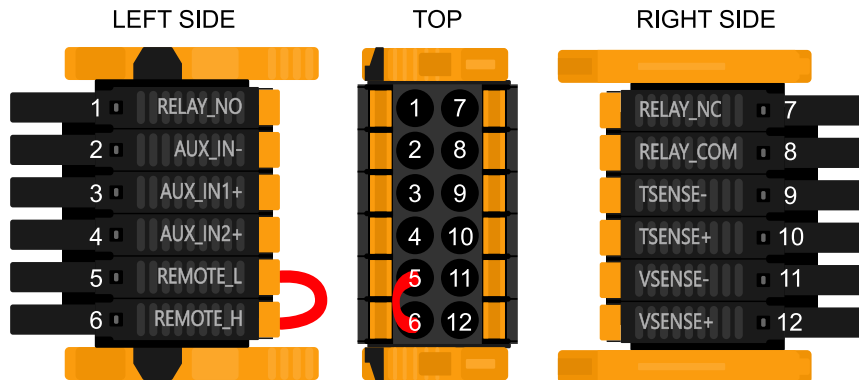

User I/O Connector is located on bottom left side of connection area, diagram shows 3 perspectives. Left Side - Top - Right Side

### 3.8.7. User I/O functions

Table 2. User I/O Functions - See Installation Section for more details.

Number	Connection	Description
1	Relay_NO	Programmable relay Normally Open connection
2	AUX_IN -	Common negative for programmable auxiliary inputs
3	AUX_IN1+	Programmable auxiliary input 1 positive connection
4	AUX_IN2+	Programmable auxiliary input 2 positive connection
5	REMOTE_L	Remote on/off connector Low
6	REMOTE_H	Remote on/off connector High
7	RELAY_NC	Programmable relay Normally Closed connection
8	RELAY_COM	Programmable relay common negative
9	TSENSE -	Temperature Sensor negative
10	TSENSE +	Temperature Sensor positive
11	VSENSE -	Voltage Sensor negative
12	VSENSE +	Voltage Sensor positive

## 4. Configuration

### 4.1. Configuring via the VictronConnect app

The VictronConnect app can be used to change all settings and to update the firmware.

The VictronConnect app can connect to the inverter via:

- Local - via built in Bluetooth
- Local - via USB using the VE.Direct to USB interface connected to the VE.Direct port.
- Local - via Bluetooth using the VE.Direct Bluetooth Smart dongle connected to the VE.Direct port.
- Remotely - via the VRM portal and a GX device. (see VRM tab in the VictronConnect device list).

How to connect to the inverter with the VictronConnect app:

- Open the VictronConnect app
- Ensure that the inverter is powered
- Look for the inverter to appear in the device list in the "Local" or the "VRM" tab
- Click on the inverter.
- In case of a connection via Bluetooth: Enter the default PIN code: 000000. After entering the default PIN code VictronConnect will ask you to change the PIN code. This is to prevent unauthorized connections in the future. It is recommended that you change the PIN code on first install. This can be done in the product info tab.

To view and/or change battery monitor settings:

- Navigate to the settings page by clicking on the cog icon  at the top right of the home screen.



This manual only covers the inverter specific items. For more general information on the VictronConnect app, like how use it, where to download it or how to connect, see the [VictronConnect app product page](#) and the [VictronConnect manual](#) or scan below QR code:



## 4.2. Battery settings

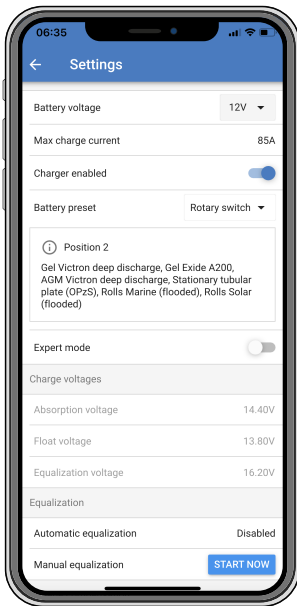

### Battery voltage

The RS is fixed to 48V, and is only available for 48V systems.

### Max charge current

Allows the user to set a lower maximum charge current.

### Charger enabled

Toggling this setting turns the Solar Charger off. The batteries will not be charged. This setting is intended only for use when carrying-out work on the installation.

### Charger settings - Battery preset

Battery preset allows you to select the battery type; accept factory defaults; or enter your own preset values to be used for the battery charge algorithm. The Absorption voltage, Absorption time, Float voltage, Equalisation voltage and Temperature compensation settings are all configured to a preset value - but can be user-defined.

User-defined presets will be stored in the preset library - in this way installers will not have to define all the values each time they are configuring a new installation.

By selecting *Edit Presets*, or on the Settings screen (with expert mode on or not), custom parameters can be set as follows:

### Absorption voltage

Set the absorption voltage.

### Adaptive absorption time

Select with adaptive absorption time or fixed absorption time will be used. Both are better explained below:

**Fixed absorption time:** The same length of absorption is applied every day (when there is enough solar power) by using the maximum absorption time setting. Be aware that this option can result in overcharging your batteries, especially for lead batteries and system with shallow daily discharges. See your battery manufacturer for recommended settings. *Note:* make sure to disable the tail current setting to make the same absorption time every day. The tail current could end absorption time sooner if the battery current is below the threshold. See more information on the tail current setting section below.

**Adaptive absorption time:** The charge algorithm can use an adaptive absorption time: it automatically adapts to the state of charge in the morning. The maximum duration of the absorption period for the day is determined by the battery voltage as measured just before the solar charger begins operation each morning (12 V battery values used - Multiply Battery voltage by 4 for 48V ):

Battery voltage Vb (@start-up)	Multiplier	Maximum absorption times
Vb < 11.9 V	x 1	06:00 hours
> 11.9 V Vb < 12.2 V	x 2/3	04:00 hours
> 12.2 V Vb < 12.6 V	x 1/3	02:00 hours

Battery voltage Vb (@start-up)	Multiplier	Maximum absorption times
Vb > 12.6 V	x 2/6	01:00 hours

The multiplier is applied to the maximum absorption time setting and this results in the maximum duration of the absorption period used by the charger. The maximum absorption times shown in the last column of the table are based on the default maximum absorption time setting of 6 hours.

#### Maximum absorption time (hh:mm)

Set the absorption time limit. Only available when using a custom charge profile.

Enter the time value in the notation hh:mm, where hours are between 0 and 12; and minutes are between 0 and 59.

#### Float voltage

Set the float voltage.

#### Re-bulk voltage offset

Set the voltage offset that will be used over the float voltage setting that will determine the threshold that the charge cycle will restart.

E.g.: For a Re-bulk voltage offset of 0.1V and a float voltage setting of 13.8 V, the voltage threshold that will be used to restart the charge cycle will be 13.7 V. In other words, if the battery voltage drops below 13.7 V for one minute, the charge cycle will restart.

#### Equalization voltage

Set the equalization voltage.

#### Equalization current percentage

Set the percentage of the Max charge current setting that will be used when equalisation is performed.

#### Automatic Equalization

Set-up the frequency of the auto equalize function. Available options are between 1 and 250 days:

- 1 = daily
- 2 = every other day
- ...
- 250 = every 250 days

Equalization is typically used to balance the cells in a lead battery, and also to prevent stratification of the electrolyte in flooded batteries. Whether (automatic) equalization is necessary, or not, depends on the type of batteries, and their usage. Consult your battery supplier for guidelines.

When the Automatic equalization cycle has initiated, the charger applies an equalization voltage to the battery as long as the current level stays below the equalization current percentage setting of the bulk current.

#### Duration of the Automatic equalization cycle

In the case of all VRLA batteries and some flooded batteries (algorithm number 0, 1, 2 and 3) automatic equalization ends when the voltage limit (maxV) has been reached, or after a period equal to (absorption time/8) - whichever comes first.

For all tubular plate batteries (algorithm numbers 4, 5 & 6); and also for the user-defined battery type, automatic equalization will end after a period equal to (absorption time/2).

For the Lithium battery type (algorithm number 7), equalization is not available.

When an automatic equalization cycle is not completed in one day, it will not resume the next day. The next equalization session will take place according to the interval set in the 'Auto Equalization' option.

The default battery type is a VRLA battery and any user-defined battery will behave as a tubular plate battery with regard to equalization.

#### Equalisation stop mode

Set how the equalisation will end. There are two possibilities, first is if the battery voltage reaches the equalisation voltage and the second is on fixed time, where the maximum equalisation duration is used.

#### Maximum equalisation duration

Set the maximum time that the equalisation phase will last.

#### Tail current

Set the current threshold that will be used to finish absorption phase before the maximum absorption time expires. When the battery current gets below the tail current for one minute, the absorption phase will end. This setting can be disabled by setting it to zero.

**Temperature compensation**

Many types of battery require a lower charge voltage in warm operating conditions, and a higher charge voltage in cold operating conditions.

The configured coefficient is in mV per degree Celsius for the whole battery bank, not per cell. The base temperature for the compensation is 25°C (77°F), as shown in the chart below.

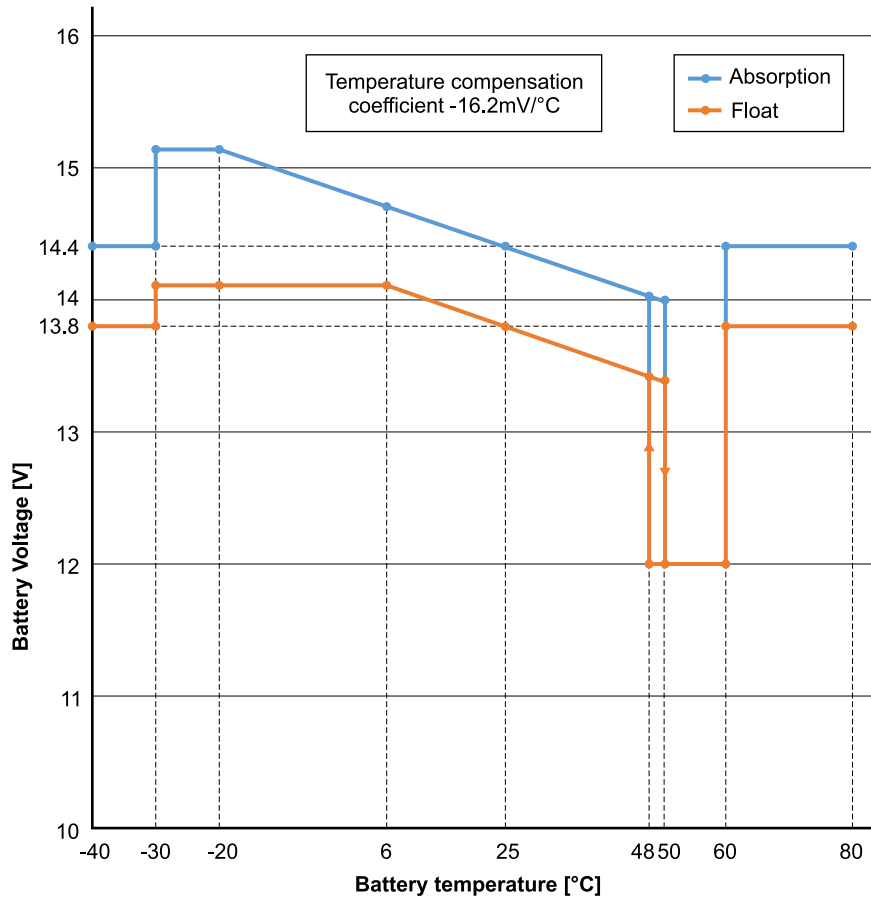

With a temperature sensor installed to the User I/O connection block; the actual battery temperature will be used for compensation; throughout the day.

**Low temperature cut-off**

This setting can be used to disable charging at low temperatures as required by Lithium batteries.

For Lithium Iron Phosphate batteries this setting is preset at 5 degrees Celsius, for the other battery types it is disabled. When creating a user defined battery the cut-off temperature level can be adjusted manually.

**Manual Equalization - Start now**

Selecting 'Start now' on 'Manual equalisation' allows manual initiation of an Equalization cycle. To allow the charger to equalize the battery properly use the manual equalize option only during absorption and float periods, and when there is sufficient sunlight. Current and voltage limits are identical to the automatic equalize function. The duration of the equalisation cycle is limited to a maximum of 1 hour when triggered manually. Manual equalization can be stopped at any time by selecting 'Stop Equalize'.

**4.3. Inverter settings**

The following inverter settings can be configured:

Setting	Explanation	Default	Range
Output voltage	Inverter AC output voltage	230V	210V to 245V
Output frequency	Inverter AC output frequency	50Hz	50Hz or 60Hz

Setting	Explanation	Default	Range
Ground relay	<p>When this setting is enabled, Neutral (N) will be connected to protective earth (PE) when the inverter is operational. This connection will be broken when the inverter is not operational.</p> <p>When this setting is disabled, neutral (N) will never be connected to protective earth (PE).</p>	enabled	enabled or disabled

#### 4.4. Programmable relay

Programmable relay which can be set for general alarm, DC under voltage or genset start/stop function. DC rating: 4A up to 35VDC and 1A up to 70VDC

#### 4.5. Connecting to AC PV inverters

The inverter includes a built in AC PV inverter detection system. When there is a feedback of AC PV (a surplus) from the AC-out connection port, the inverter will automatically enable an AC output frequency adjustment.

While no further configuration is required, it is important that the AC PV inverter is configured correctly to respond to the frequency adjustment by reducing its output.

Note the 1:1 rule of AC PV inverter size to inverter size, and minimum battery sizing applies. More information about these limitations are available in the [AC Coupling manual](#), and this document is required reading if using an AC PV inverter.

The frequency adjustment range is not configurable, and includes a built in safety margin. Once the absorption voltage is reached, the frequency will increase. So it is still essential to include a DC PV component in the system for complete battery charging (i.e. float stage).

It may be possible to adjust the power output response to various frequencies on your AC PV inverter.

The default configuration has been tested and works reliably with the Fronius MG50/60 grid code configuration.



## 5. Operation

### 5.1. Device display

The Inverter RS has an LCD screen that displays operational information.

**Inverter:**

Inverter state, Power output, Frequency and AC Voltage

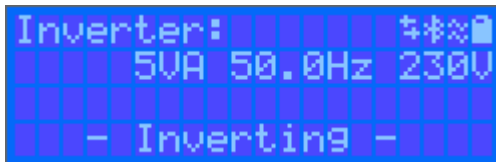

**Battery:**

Battery Power (charging shows positive number, discharging shows negative number), Current, DC voltage, Temperature (\*), State-of-charge (\*) and Time-to-go (\*). Battery state (e.g. discharging, bulk, absorption, float, etc).

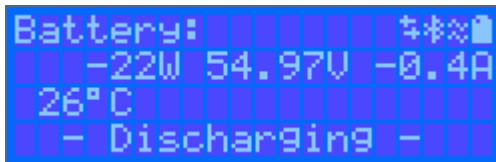

(\*) These items are only visible if the data is available.

Solar Power, Voltage and Current, kWh daily and total Yield.

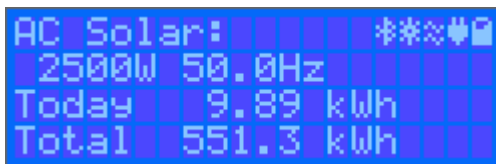

	Communicating on any interface (e.g., Bluetooth, VE.Can, etc.)
	Bluetooth Enabled, Icon colour changes when connected
	(Blinking) Error or Warning
	Inverter Active
	Battery, fill corresponds with voltage, blinks when empty

### 5.2. Protections and automatic restarts

#### 5.2.1. Overload

Some loads like motors or pumps draw large inrush currents during start-up. In such circumstances, it is possible that the start-up current exceeds the over current limit of the inverter. In this case the output voltage will quickly decrease to limit the output current of the inverter. If the over current limit is continuously exceeded, the inverter will shut down for 30 seconds and then automatically restart. After three restarts followed by overload within 30 seconds of restarting, the inverter will shut down and remain off. To restart normal operation, disconnect the load, Switch Off the inverter, then switch it On.

### 5.2.2. Low battery voltage thresholds (adjustable in VictronConnect)

The inverter will shut down when the DC input voltage drops below the low battery shutdown level. After a minimum shutdown time of 30 seconds, the inverter will restart if the voltage has risen above the low battery restart level.

After three shut down and restarts, followed by a low battery shutdown within 30 seconds of restarting, the inverter will shut down and stop retrying based on the low battery restart level. To override this and restart the inverter, switch it Off, and then On, and limit loads to enable recharging of the battery with solar energy.

See the Technical Data table for default low battery shut down, restart and charge detect levels. They can be adjusted with VictronConnect (computer or app).

Additionally another external MPPT or battery charger can also be used to recharge the battery to reach the Restart Voltage or Charge Detect voltage level. !!! If using the allow to charge signal functionality, it must remain above the minimum voltage, so if the battery is completely dead it will not allow charging to start. In this case, you can temporarily disable this function in VictronConnect to allow charging to resume, then enable it again.

See the Technical Data table for default low battery shut down and restart levels. They can be changed with VictronConnect (computer or app). Alternatively Dynamic Cut-off can be implemented, see <https://www.victronenergy.com/live/ve.direct:phoenix-inverters-dynamic-cutoff>

### 5.2.3. High battery voltage

Reduce DC input voltage and/or check for a faulty battery- or solar-charger in the system. After shutting down due to a high battery voltage, the unit will first wait 30 seconds and then retry operation as soon as the battery voltage has dropped to acceptable level.

### 5.2.4. High temperature

A high ambient temperature or enduring high load may result in shut down to over temperature. The inverter will restart after 30 seconds. The inverter will continue to try and resume operation, and will not stay off after multiple retries. Reduce load and/or move inverter to better ventilated area.

## 6. Troubleshooting and Support

Consult this chapter in case of unexpected behaviour or if you suspect a product fault.

The correct troubleshooting and support process is to first consult the common issues as described in this chapter.

Should this fail to resolve the issue, contact the point of purchase for technical support. If the point of purchase is unknown, refer to the [Victron Energy Support webpage](#).

### 6.1. Error Codes

#### 6.1.1. Error 2 - Battery voltage too high

This error will auto-reset after the battery voltage has dropped. This error can be due to other charging equipment connected to the battery or a fault in the charge controller.

#### 6.1.2. Error 3, Err 4 - Remote temperature sensor failure

Check if the T-sense connector is properly connected to a remote temperature sensor. Most likely cause: the remote T-sense connector is connected to the BAT+ or BAT- terminal. This error will auto-reset after proper connection.

#### 6.1.3. Error 5 - Remote temperature sensor failure (connection lost)

Check if the T-sense connector is properly connected to a remote temperature sensor. This error will not auto-reset.

#### 6.1.4. Error 6, Error 7 - Remote battery voltage sense failure

Check if the V-sense connector is properly connected to the battery terminals. Most likely cause: the remote V-sense connector is connected in reverse polarity to the BAT+ or BAT- terminals.

#### 6.1.5. Error 8 - Remote battery voltage sense failure (connection lost)

Check if the V-sense connector is properly connected to the battery terminals.

#### 6.1.6. Error 11 - Battery high ripple voltage

High DC ripple is usually caused by loose DC cable connections and/or too thin DC wiring. After the inverter has switched off due to high DC ripple voltage, it waits 30 seconds and then restarts.

After three restarts followed by a shutdown due to high DC ripple within 30 seconds of restarting, the inverter will shutdown and stops retrying. To restart the inverter, switch it Off and then On.

Continuous high DC ripple reduces the inverter life expectancy

#### 6.1.7. Error 14 - Battery low temperature

The charger is stopped to avoid charging LiFePO4 batteries at low temperature as this damages the cells.

#### 6.1.8. Error 20 - Maximum Bulk-time exceeded

##### Solar Chargers

The maximum bulk time protection is a feature that was in the chargers when they were just released (2015 or earlier) and later the feature was removed.

If you do see this error, then update to the latest firmware.

If you then still have the error, perform a reset to factory defaults of the configuration, and reconfigure the solar charger.

##### AC Chargers

This protection is default enabled on the Skylla-i and the Skylla IP44.

This error is generated when the battery-absorption-voltage is not reached after 10 hours of charging.

The feature of this safety protection is to detect a shorted cell; and stop charging.

### 6.1.9. Error 22, 23 - Internal temperature sensor failure

The internal temperature measurements are out of range. Disconnect all wires, and then reconnect all wires, to restart the unit. This error will not auto-reset. If the error remains, please contact your dealer, there might be a hardware defect.

### 6.1.10. Error 26 - Terminal overheated

Power terminals overheated, check wiring, including the wiring type and type of strands, and/or fasten bolts if possible.

This error will auto-reset.

### 6.1.11. Error 27 - Charger short circuit

This error will auto-reset. If the error does not auto-reset disconnect the charge controller from all power-sources, wait 3 minutes, and power up again. If the error persists the charge controller is probably faulty.

### 6.1.12. Error 28 - Power stage issue

This error will not auto-reset.

Disconnect all wires, and then reconnect all wires. If the error persists the charge controller is probably faulty.

Note that this error was introduced in v1.36. So when doing an update, it might look like the firmware update caused this issue; but it doesn't. The Solar charger was then already not performing 100% before the update; updating to v1.36 or later merely made the issue more visible. The unit needs to be replaced.

### 6.1.13. Error 29 - Over-Charge protection

This error will auto-reset. This protection looks at the actual battery voltage and compares this to the settings. In case your actual voltage is above what is expected it shuts down to isolate the battery from the rest of the unit. Firstly check battery settings (absorption/float voltages) to see if something is wrong here. Another possible cause is an over-sized PV array configuration, if there are too many panels in series the battery voltage cannot be reduced any further. Consider modifying PV panel wiring to reduce the PV voltage.

### 6.1.14. Error 43 - Inverter shutdown (Ground Fault)

The voltage difference between Neutral and Ground is too high.

Inverter or Multi (not connected to the grid):

- The internal ground relay is activated but the voltage over the relay is too high. The relay might be damaged.

Multi (connected to the grid):

- The ground wire in the installation is not present or not connected properly.
- Line and Neutral are swapped in the installation.

This error will not auto-reset. Check the installation and restart the unit using the power-switch.

### 6.1.15. Error 50, Error 52 - Inverter overload, Inverter peak current

Some loads like motors or pumps draw large inrush currents in a start-up situation. In such circumstances, it is possible that the start-up current exceeds the over current trip level of the inverter. In this case the output voltage will quickly decrease to limit the output current of the inverter. If the over current trip level is continuously exceeded, the inverter will shut down: wait 30 seconds and then restart.

The Inverter can supply more power than the nominal power level for a short time. If the time is exceeded the inverter stops.

After three restarts followed by another overload within 30 seconds of restarting, the inverter will shutdown and remain off. To restart the inverter, switch it Off, then On.

If the error persists reduce the load on the AC out terminal by switching off or disconnecting appliances.

### 6.1.16. Error 51 - Inverter temperature too high

A high ambient temperature or enduring high load may result in shut down to over temperature. Reduce load and/or move inverter to better ventilated area and check for obstructions near the fan outlets.

The inverter will restart after 30 seconds. The inverter will not stay off after multiple retries.

### 6.1.17. Error 53, Error 54 - Inverter output voltage

If the battery voltage is getting low and a large load is applied to the AC output the inverter is unable to maintain the proper output voltage. Re-charge the battery or reduce the AC loads to continue operation.

### 6.1.18. Error 55, Error 56, Error 58 - Inverter self test failed

The inverter performs diagnostic tests before it activates its output. In the case that one of these tests fails an error message is displayed and the inverter does not turn on.

First try to restart the inverter, by switching it Off, and then On. If error persists the inverter is probably faulty.

### 6.1.19. Error 57 - Inverter ac voltage on output

There is already AC voltage on the AC out terminal before switching on the inverter. Check that the AC out is not connected to a mains outlet or to another inverter.

This error will not auto-reset. Check the installation and restart the unit using the power-switch.

### 6.1.20. Notification 65 - Communication warning

Communication with one of the paralleled controllers was lost. To clear the warning, switch the controller off and back on

### 6.1.21. Notification 66 - Incompatible device

The controller is being paralleled to another controller that has different settings and/or a different charge algorithm.

Make sure all settings are the same and update firmware on all chargers to the latest version

### 6.1.22. Error 67 - BMS Connection lost

The charger is configured to be controlled by a BMS, but it does not receive any control messages from a BMS. The charger stopped charging, as a safety precaution.

This Error only shows when there is solar power available and thus the Solarcharger is ready to initiate charging. It does not show at night. And in case there is a permanent problem, the error will raise in the morning and clear at night, and so forth.

Check the connection between the charger and the BMS.

[How to reconfigure the charger to standalone mode](#)

Our Chargers and Solarchargers automatically configure themselves to be BMS-controlled when they are connected to one; either direct or via a GX Device. And that setting is semi-permanent: power cycling the charger will not reset it.

Here is what needs to be done to make the charger operate in stand-alone mode again, ie. not controlled by a BMS:

- VE.Can solar chargers, go into the setup menu, and change setting 'BMS' from 'Y' to 'N' (setup item 31).
- VE.Direct solar chargers, reset the charger to factory defaults with VictronConnect, and then reconfigure it.

### 6.1.23. Error 68 - Network misconfigured

Applies to SmartSolar/BlueSolar MPPTs VE.Can (FW version v1.04 or higher) and SmartSolar VE.Direct MPPTs (FW version v1.47).

To clear the error on the SmartSolar VE.Direct MPPTs update the FW version to v1.48 or higher.

To clear the error on the SmartSolar/BlueSolar MPPTs VE.Can, update the software. If the error persists, it will be because the charger is connected with both a VE.Direct cable and on VE.Can. That is not supported. Remove one of the two cables. The error will disappear and the charger will resume normal operation, within a minute.

### 6.1.24. Error 114 - CPU temperature too high

This error will reset after the CPU has cooled down. If the error persists, check the ambient temperature and check for obstructions near the air inlet and outlet holes of the charger cabinet. Check manual for mounting instructions with regard to cooling. If error persists the controller is probably faulty.

### 6.1.25. Error 116 - Calibration data lost

If the unit does not work and error 116 pops up as the active error the unit is faulty, contact your dealer for a replacement.

If the error is only present in the history data and the unit operates normally this error can be ignored safely. Explanation: when the units power up for the very first time in the factory, it does not have calibration data and an error 116 is logged. Obviously this should have been cleared, but in the beginning units left the factory with this message still in the history data.

SmartSolar models (not the BlueSolar models): upgrading to v1.4x firmware is a one-way trip, you cannot go back to an older firmware version once you upgrade to v1.4x. Reverting to older firmware gives error 116 (calibration data lost), this can be fixed by re-installing the v1.4x firmware.

#### **6.1.26. Error 119 - Settings data lost**

The charger cannot read its configuration, and stopped.

This error will not auto-reset. To get it working again:

1. First, restore it to factory defaults. (top right in Victron Connect, click on the three dots)
2. Disconnect the charge controller from all power-sources
3. wait 3 minutes, and power up again.
4. Reconfigure the charger.

Please report this to your Victron dealer and ask them to escalate the matter to Victron; as this error should never happen. Preferably include firmware version and any other specifics (VRM URL, VictronConnect screenshots or similar).

#### **6.1.27. Error 121 - Tester fail**

If the unit does not work and error 121 pops up as the active error the unit is faulty, contact your dealer for a replacement. If the error is only present in the history data and the unit operates normally this error can be ignored safely. Explanation: when the unit powers up for the very first time in the factory, it does not have calibration data and an error 121 is logged. Obviously this should have been cleared, but in the beginning units left the factory with this message still in the history data.

#### **6.1.28. Err 200, X95 - Internal DC voltage error**

The unit performs internal diagnostics when activating its internal DC-DC converter. This error indicates that something is wrong with the DC-DC converter.

This error will not auto-reset. Check the installation and restart the unit using the power-switch. If the error persists the unit is probably faulty.

#### **6.1.29. Err 201 - Internal DC voltage error**

Internal DC voltage measurement error, is raised in case an internal (high-) voltage measurement does not match certain criteria. And it means that a measurement circuit inside the unit is broken.

Make sure to update the firmware to at least v1.08, in previous firmwares the limits were too strict. And it could trigger falsely during MPPT start-up in the morning and MPPT shutdown in the evening.

The unit might have seemingly worked fine before the firmware update; but it is really broken, not safe for use, and if it hadn't stopped working already then it would have stopped working soon. Which is why we added this internal check.

This error will not auto-reset. Check the installation and restart the unit using the power-switch. If the error persists the unit is probably faulty and must be sent in for repair/replacement.

#### **6.1.30. Err 203, Err 205, Err 212, Err 215 - Internal supply voltage error**

The unit performs internal diagnostics when activating its internal voltage supplies. This error indicates that something is wrong with an internal supply voltage.

This error will not auto-reset. Check the installation and restart the unit using the power-switch. If the error persists the unit is probably faulty.

## 7. Warranty

This product has a 5-year limited warranty. This limited warranty covers defects in materials and workmanship in this product and lasts for five years from the date of original purchase of this product. To claim warranty the customer must return the product together with the receipt of purchase to the point of purchase. This limited warranty does not cover damage, deterioration or malfunction resulting from alteration, modification, improper or unreasonable use or misuse, neglect, exposure to excess moisture, fire, improper packing, lightning, power surges, or other acts of nature. This limited warranty does not cover damage, deterioration or malfunction resulting from repairs attempted by anyone unauthorized by Victron Energy to make such repairs. Non-compliance with the instructions in this manual will render the warranty void. Victron Energy is not liable for any consequential damages arising from the use of this product. The maximum liability of Victron Energy under this limited warranty shall not exceed the actual purchase price of the product.

## 8. Technical Specifications

	Inverter RS Smart Solar
	<b>INVERTER</b>
DC Input voltage range	38 – 62V
Output	Output voltage: 230 VAC $\pm$ 2% Frequency: 50 Hz $\pm$ 0,1% (1)
Continuous output power at 25°C	Increases linearly from 4800W at 46 VDC to 5300W at 52 VDC
Continuous output power at 40°C	4500W
Continuous output power at 65°C	3000W
Peak power	9kW for 3 seconds
Short-circuit output current	50 A
Max. AC output overcurrent protection	30 A
Maximum efficiency	96.5% at 1 kW load 94% at 5 kW load
Zero load power	20W
Low battery shutdown	37.2 V (adjustable)
Low battery restart	43.6 V (adjustable)
	<b>CHARGER</b>
Programmable charger voltage range (2)	Minimum: 36 V Maximum 60 V (8)
Charge voltage 'absorption'	default: 57.6 V (adjustable)
Charge voltage 'float'	default: 55.2 V (adjustable)
Maximum charge current (4)	100 A
Battery temperature sensor	Included
Battery voltage sense	Yes
	<b>GENERAL</b>
Parallel and 3-phase operation	No
Auxiliary output	No
Programmable relay (5)	Yes
Protection (6)	a - f
Data Communications	VE.Direct port, VE.Can port & Bluetooth (7)
Bluetooth frequency	2402 - 2480 Mhz
Bluetooth power	4dBm
General purpose analog/digital in port	Yes, 2x
Remote on-off	Yes
Operating temperature range	-40 to +65°C (fan assisted cooling)
Humidity (non-condensing)	max 95%
	<b>ENCLOSURE</b>
Material & Color	steel, blue RAL 5012
Protection category	IP21
Battery-connection	M8 bolts
230 V AC-connection	Screw terminals 13 mm <sup>2</sup> (6 AWG)



	Inverter RS Smart Solar
Weight	11 kg
Dimensions (hxwxd)	
	<b>STANDARDS</b>
Safety	EN-IEC 60335-1, EN-IEC 60335-2-29, EN-IEC 62109-1, EN-IEC 62109-2
Emission, Immunity	EN 55014-1, EN 55014-2 EN-IEC 61000-3-2, EN-IEC 61000-3-3 IEC 61000-6-1, IEC 61000-6-2, IEC 61000-6-3
<p>1) Can be adjusted to 60 Hz</p> <p>5) Programmable relay which can be set for general alarm, DC under voltage or genset start/stop function, including minimum closed time and relay-off delay. DC rating: 4A up to 35VDC and 1A up to 70VDC</p> <p>6) Protection key:</p> <ul style="list-style-type: none"> <li>a) output short circuit</li> <li>b) overload</li> <li>c) battery voltage too high</li> <li>d) battery voltage too low</li> <li>e) temperature too high</li> <li>f) 230 VAC on inverter output</li> </ul> <p>7) The Inverter RS is not currently compatible with VE.Smart Networks. Connection to a GX device (i.e. Cerbo GX) must be made via the VE.Can interface. The VE.Direct interface is for connection to the GlobalLink 520.</p>	

## 9. Appendix

### 9.1. Appendix A : Connection Overview

Figure 2. Inverter RS Smart Front

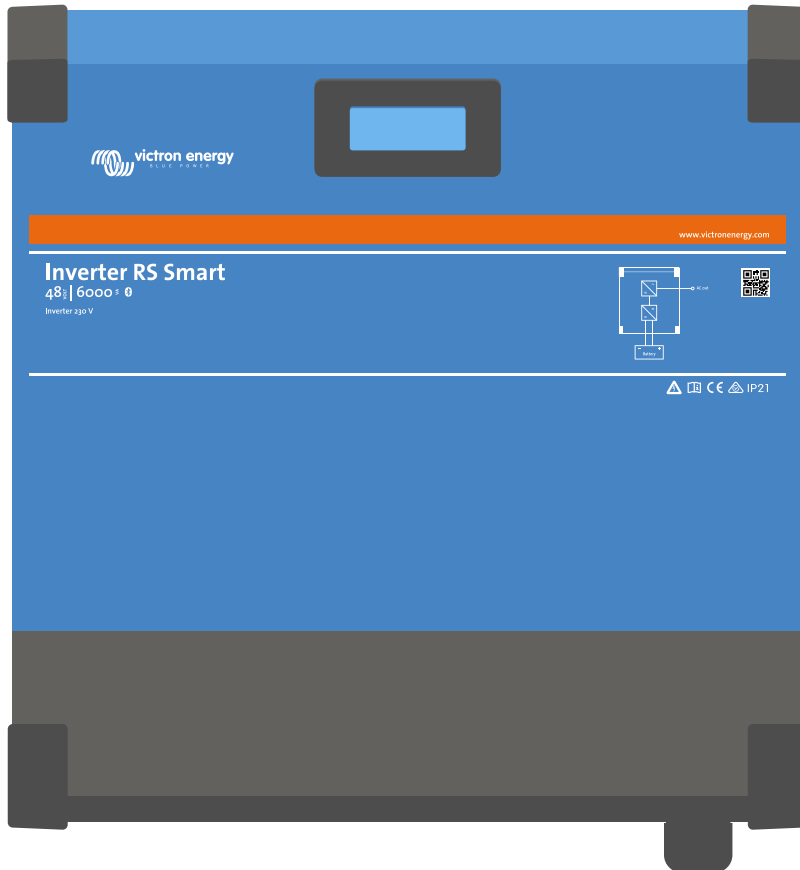
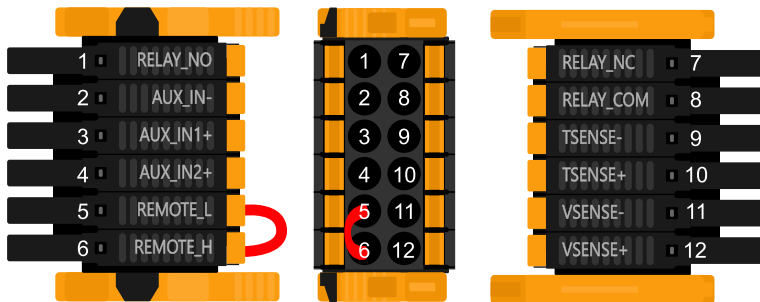

Figure 3. Inverter RS Smart Bottom



Figure 4. User I/O



User I/O Connector is located on bottom left side of connection area, diagram shows 3 perspectives. Left Side - Top - Right Side

Table 3. User I/O Functions - See Installation Section for more details.

Number	Connection	Description
1	Relay_NO	Programmable relay Normally Open connection
2	AUX_IN -	Common negative for programmable auxiliary inputs
3	AUX_IN1+	Programmable auxiliary input 1 positive connection
4	AUX_IN2+	Programmable auxiliary input 2 positive connection
5	REMOTE_L	Remote on/off connector Low
6	REMOTE_H	Remote on/off connector High
7	RELAY_NC	Programmable relay Normally Closed connection
8	RELAY_COM	Programmable relay common negative
9	TSENSE -	Temperature Sensor negative
10	TSENSE +	Temperature Sensor positive
11	VSENSE -	Voltage Sensor negative
12	VSENSE +	Voltage Sensor positive

## 9.2. Appendix B : Block Diagram

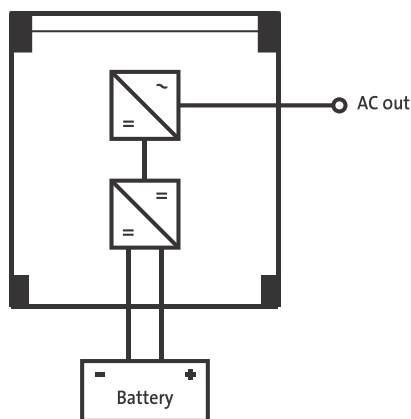

### 9.3. Appendix C : Example Wiring Diagram

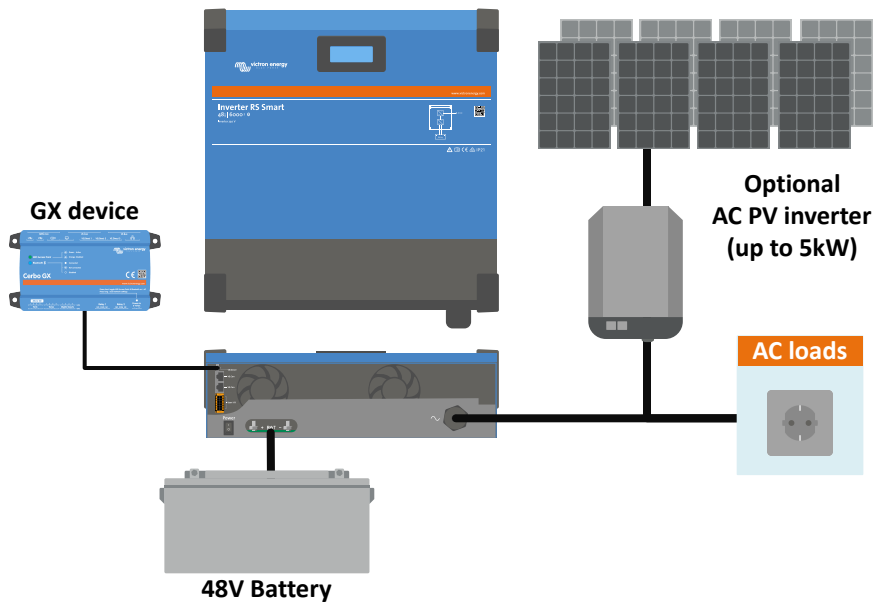

### 9.4. Appendix D : Dimensions

